

# Installation Instructions

## ROLLERSHADES

Natural woven and performance rollershade styles



Natural Roller Style

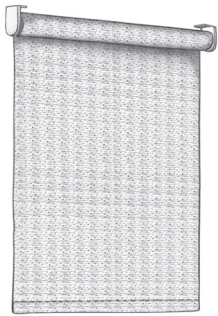

Performance Rollershade

### Before You Begin

Please promptly remove shades from packaging to minimize creasing and wrinkling. Each shade is labeled to help match shade to window installation.

Order & Item Numbers

Operation

Dimensions, Mounting

#### PACKAGE LABEL

<b>100000-002</b>	<b>ROLLERSHADE: GRASSWEAVE [W</b>	<b>1 of 1</b>	<b>06/05/2019</b>
1 SHADES USA	PO: 100000	SM: LIVINGSTON	
<b>MANUAL CLUTCH</b>		<b>LE1052 Elements Batiste</b>	
50 X 60	MNT:OUTSIDE	RM: LIVING	Location
<b>HARTMANN &amp; FORBES (TUA)</b>			
<b>TUALATIN, OR</b>			

### TOOLS REQUIRED

- Power Driver
- 1/2" Extension Hex or Phillips Bit
- Level
- Wall Fasteners
- Tape Measure
- 1/16" Drill Bit
- Pencil
- Pliers

### INSTALLATION HARDWARE (included)

Quantity and type of hardware included depends on shade style, width, specifications and control method. Bracket Mounting instructions apply to all roller brackets.

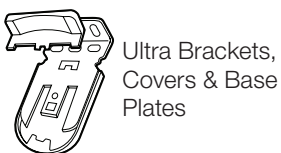

Ultra Brackets, Covers & Base Plates

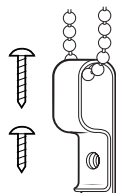

Tension Device, Long & Short Wood Screws

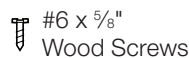
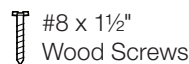
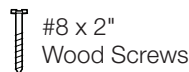

### WALL FASTENERS (not included)

Brackets and other hardware must be securely mounted to wall or other installation surface. Surfaces may vary so use appropriate fasteners.

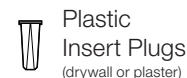
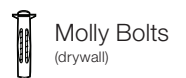

# BRACKET MOUNTING

Ensure that the bracket is mounted far enough away from the wall to install the bracket cover. Brackets need to be completely level for shade to function properly.



## Vertical Installation

**1** Measure the diameter of the rolled up shade. Align brackets in window casement to half the roll diameter measurement plus 1/4" for clearance.

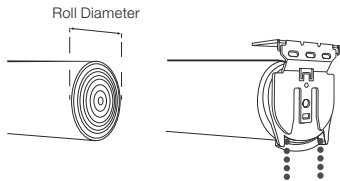

**2** Mark bracket location in window casing. Ensure there is enough horizontal clearance to attach the shade to the brackets when fastened.

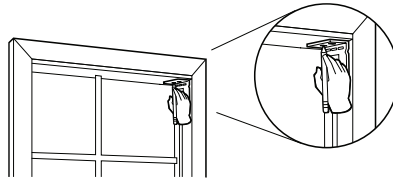

**3** Install brackets at marked locations so that the feet face inward using #8 x 1 1/2" wood screws and appropriate fasteners through the top holes.

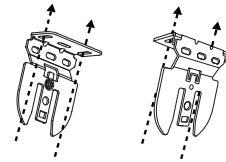

## Horizontal Installation

Level brackets so that they are aligned. Use fully rolled up shade as a guide to determine if you need to allow for clearance from ceiling, casing or wall and make adjustments as needed.

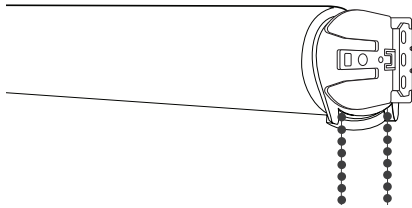

**OUTSIDE MOUNT:** Install brackets so that feet face inward using #8 x 1 1/2" wood screws and appropriate fasteners through the back holes.

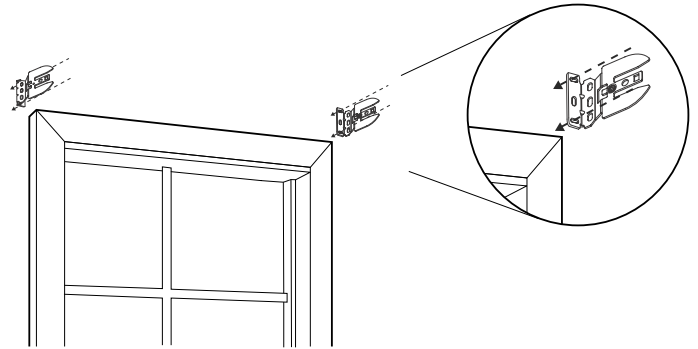

# ROLLERSHADE MOUNTING

**1** Snap base plate covers onto brackets to cover installation screws.

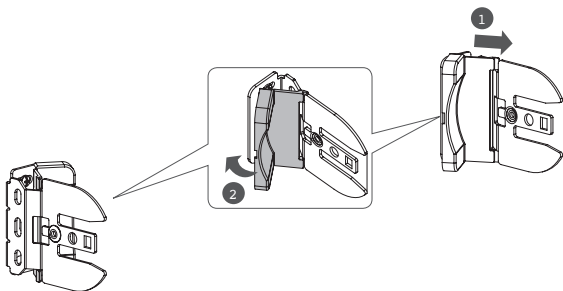

**2** Snap idler pin into the bracket that is opposite the clutch location (if the clutch is right, this will be left).

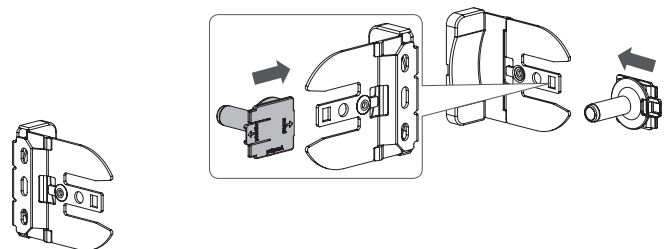

- 3** Hold up rollershade and slide end onto the idler.

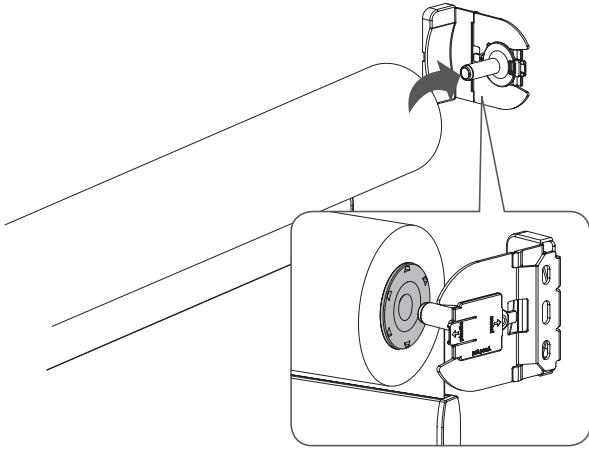

- 4** While continuing to hold shade onto the idler bracket, snap clutch/motor into the bracket (note: for larger shades two people are required).

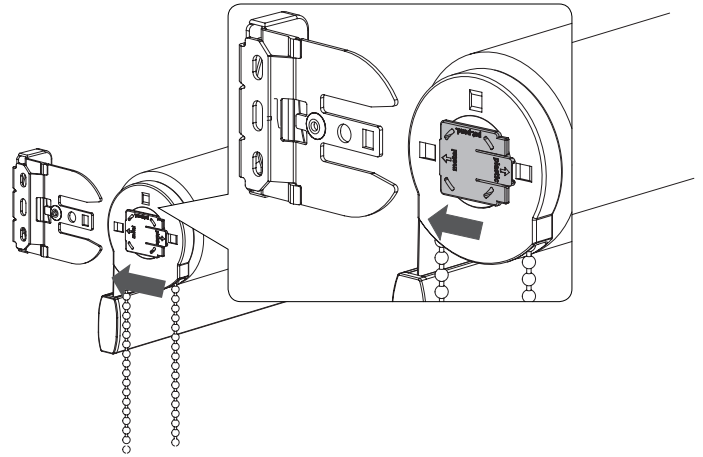

- 5** Install bracket covers over each bracket.

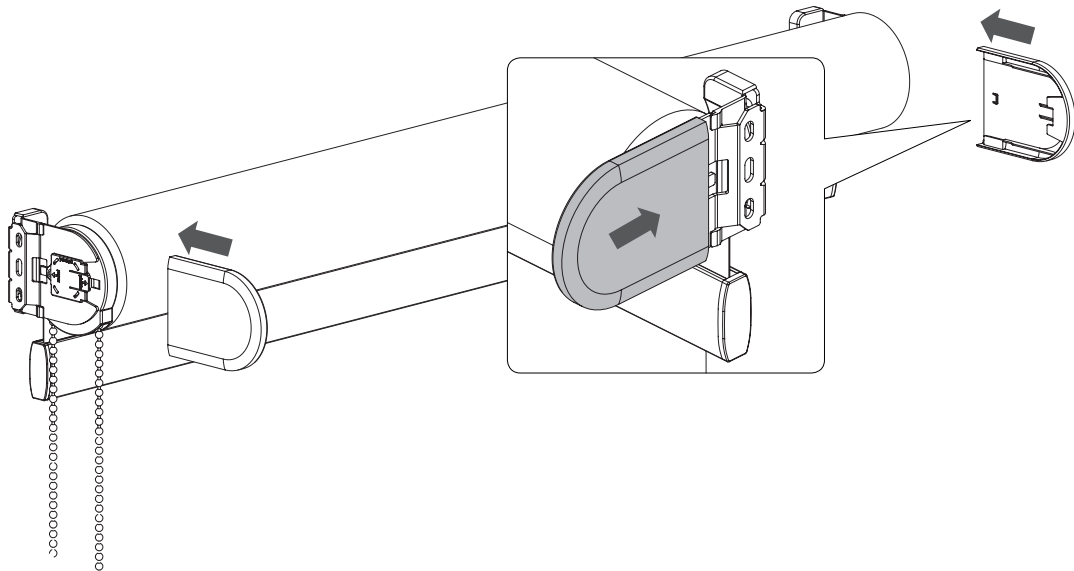

## Door Mount Shades

- 1** Anchor brackets directly into the door following Horizontal Bracket Mounting instructions.
- 2** Mount the rollershade to the installed brackets following the Rollershade Mounting instructions.
- 3** Install control guide following the instructions in the Safety Device section.

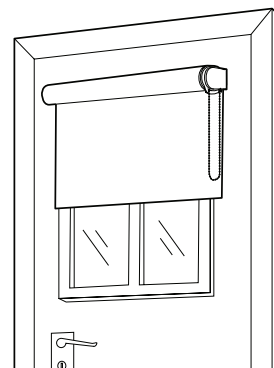

# SAFETY DEVICE Installation Instructions

Shades should not be operated without the installation of the provided safety devices detailed below. Anchoring devices to the wall or window casing, and proper usage, reduces the hazards of strangulation and entanglement of young children and pets by limiting access to the control loop.



## Control Guide for Clutch Shades

- 1 Remove Safety Booklet from control loop.
- 2 Mark screw holes for mounting the control guide on windowcasing or wall.
- 3 Allow enough slack to pull operating control loop through the control guide.
- 4 Mount control guide to windowcasing or wall using color coordinating screw.

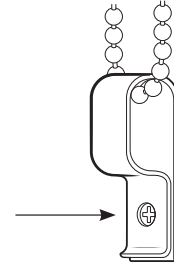

## Troubleshooting

### Performance Rollershade

If shade telescopes to the side when raised, lower the shade until the tube is exposed. Apply a small length of gaffers tape (1½" - 2") on the tube opposite the telescoping end. Raise and lower to test. If the shade continues to telescope, repeat this step until the shade tracks evenly. The correct amount of tape needed is determined by trial and error.

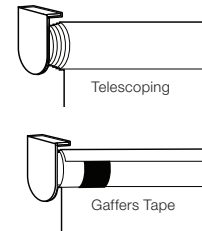

### Natural Roller Style

If telescoping, use the same process described above. If you still have issues after this process you can manually adjust by moving and compressing the material into place. For more information contact Customer Relations at [hfc@hartmannforbes.com](mailto:hfc@hartmannforbes.com)



Hover over QR code with your smartphone camera to view leveling instructions

## Care & Maintenance

- Vacuum shades with an upholstery attachment to remove dust, hair or other airborne particles.
- Prolonged exposure to the elements will result in visible wear. It is recommended to open and close shades on a regular basis to help ensure they wear more evenly.
- Ensure windows are dry to protect shades from moisture caused by window condensation or rain. Prolonged exposure to moisture and extreme humidity will cause discoloration from mildew, which can be difficult to remove.
- In the event that wrinkling occurs, use a dry iron on a low setting, increasing the heat as needed. Do not exceed the medium heat setting or use steam.

## Warranty

Hartmann&Forbes warrants to the original purchaser ("purchaser") that its windowcoverings ("products" or "the product"), when correctly installed and operated in strict accordance with the installation instructions, will be free from defects in materials and workmanship for FIVE (5) YEARS from the date of delivery (the "Warranty Period").

Subject to the following warranty exclusions, any products or parts determined to be defective during the Warranty Period will be repaired or replaced by Hartmann&Forbes at no-charge to the purchaser.

### NOT COVERED BY WARRANTY:

- Hartmann&Forbes products or parts which fail due to accident, alteration, improper use, abuse, neglect, normal wear, color-fading due to sunlight, atmospheric conditions, direct exposure to salt air or improper cleaning
- Any conditions or damage resulting from the removal of the product or reinstallation in the same or another window
- Labor costs and expenses associated with measuring and installing replacement products, shipping, packaging and returning merchandise, except as may be authorized by Hartmann&Forbes in advance
- Hartmann&Forbes motor-ready windowcoverings
- Customer-provided motors and parts
- Hartmann&Forbes Natural Wallcoverings
- Hartmann&Forbes By-the-Yard Textiles

To obtain Warranty service, contact the showroom or distributor from which you purchased your Hartmann&Forbes product(s) and, if it is determined that your claim is subject to warranty, Hartmann&Forbes will promptly repair or replace any defective parts at no-charge. Charge-backs for repair or installation costs will not be honored unless authorized by Hartmann&Forbes in advance. Hartmann&Forbes retains the right to determine the appropriate method for repairing or remaking any product.

AS-IS; NO OTHER WARRANTIES: THERE ARE NO OTHER WARRANTIES, EXPRESS OR IMPLIED, EXCEPT THIS LIMITED WARRANTY. HARTMANN&FORBES EXPRESSLY DISCLAIMS THE IMPLIED WARRANTIES OF MERCHANTABILITY AND FITNESS FOR A PARTICULAR PURPOSE.

LIMITATION OF REMEDIES: HARTMANN&FORBES SHALL NOT BE LIABLE FOR ANY DIRECT, INCIDENTAL OR CONSEQUENTIAL DAMAGES EXCEPT AS SPECIFICALLY LISTED ABOVE, AND SHALL NOT BE LIABLE IN ANY CIRCUMSTANCE FOR SPECIAL, INDIRECT, PUNITIVE, OR EXEMPLARY DAMAGES OR LOST PROFITS OF ANY KIND WHETHER BASED ON CONTRACT, WARRANTY, NEGLIGENCE, PRODUCT LIABILITY OR ANY OTHER THEORY OF RELIEF RESULTING FROM OR ARISING IN ANY WAY FROM YOUR PURCHASE OR USE OF HARTMANN&FORBES PRODUCTS.

Some states do not allow the exclusion or limitation of incidental or consequential damages, so the above limitation or exclusion may or may not apply to you.

If shade is damaged, the hardware is missing or if you need assistance please contact H&F at 888.582.8780 or email [hfc@hartmannforbes.com](mailto:hfc@hartmannforbes.com)