

Installation Instructions

TOP TREATMENTS

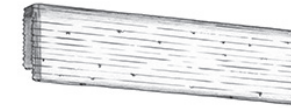

Flat Valance



Double Flat Valance



Structured Valance



Faux-Roman Valance

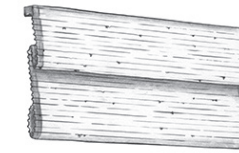

Double Hobbled Valance

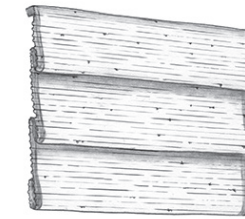

Triple Hobbled Valance

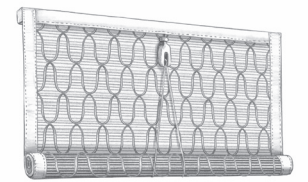

Chik Valance

Before You Begin

Please promptly remove Top Treatment from packaging to minimize creasing and wrinkling. Each Top Treatment is labeled to help match to window installation.

PACKAGE LABEL

| | | | | |
|----------------------|---|----------------------------------|--------------------------------|-------------------|
| Order & Item Numbers | 100000-002 | TOP TREATMENT: GRASSWEAVE | 1 of 1 | 06/05/2019 |
| Style | 1 SHADES-USA | PQ: 100000 | SM: LIVINGSTON | Location |
| Dimensions, Mounting | FLAT VALANCE | MNT: OUTSIDE | LE1052 Elements Batiste | |
| | 50 X 6 | | RM: LIVING | |
| |  | | | |
| | HARTMANN & FORBES (TUA) | | | |
| | TUALATIN, OR | | | |

TOOLS REQUIRED

- Power Driver
- 1/2" Extension Hex or Phillips Bit
- Level
- Wall Fasteners
- Tape Measure
- 1/16" Drill Bit
- Pencil
- Pliers

INSTALLATION HARDWARE (included)

Quantity and type of hardware included depends on Top Treatment style, width and other specifications.

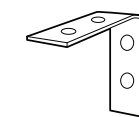

L-Brackets

 #8 x 2"
Wood Screws

 #8 x 1 1/2"
Wood Screws

 #6 x 5/8"
Wood Screws

WALL FASTENERS (not included)

Brackets and other hardware must be securely mounted to wall or other installation surface. Surfaces may vary so use appropriate fasteners.

 Self-Drilling Anchor
(drywall)

 Molly Bolts
(drywall)

 Plastic Insert Plugs
(drywall or plaster)

 Toggle Bolts
(drywall or lath & plaster)

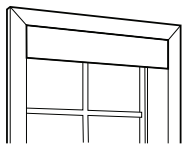

INSIDE MOUNT (IS)

- 1 Position the Top Treatment in the desired location within the window casing.

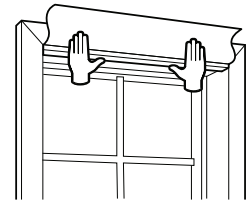

Flat Valance Shown

- 2 Locate the pre-drilled holes in the headrail. Mark holes in window casing. An "Installation Here" label indicates hole locations if headrail is fabric-wrapped.

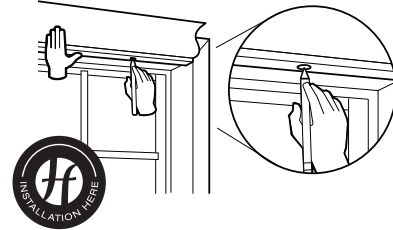

- 3 Using a 1/16" drill bit, sink pilot holes at marks in the window frame.

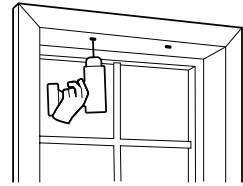

- 4 Align Top Treatment with pilot holes. Secure to window frame using #8 x 1 1/2" wood screws. Tighten center screw first to allow for adjustment.

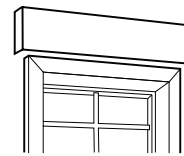
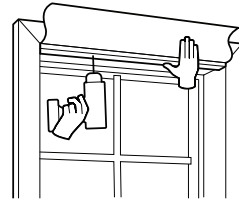

OUTSIDE MOUNT (OS)

- 1 Position the Top Treatment in desired location, centered on the wall above the window. Mark the wall along the bottom of the Top Treatment headrail where you will install the brackets 2" in from each side and every 24" in-between.

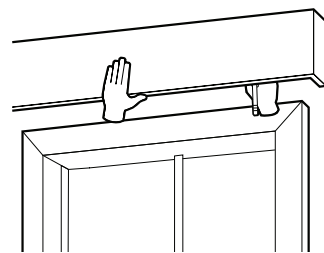

Structured Valance Shown

- 2 Starting at one side of the window, position bracket so that the top of the bracket aligns with bottom of mark. Mark bracket hole locations and sink pilot holes using 1/16" bit. Install using #8 x 1 1/2" wood screws and appropriate fasteners.

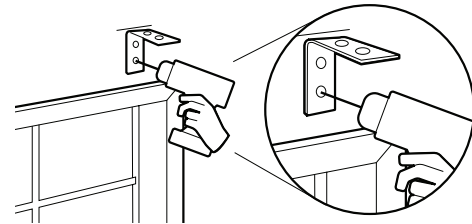

- 3 Working from one side of the window to the other, install remaining brackets. Use a level to ensure that each bracket is aligned with the first installed bracket.

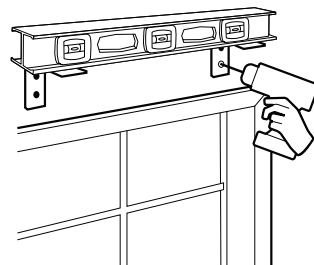

- 4 Place Top Treatment on brackets, then use #6 x 5/8" wood screws to secure the headrail to the brackets. Some Top Treatments will need to be mounted with the brackets above the headrail to allow proper operation of the shade installed within.

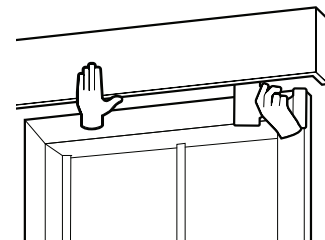

Chik Valance

Install valance following inside or outside mount installation instructions

- a. Pull cord through wood pulley until shade is at desired height.
- b. Keeping tension on cord, wrap cord around cleat on underside of headrail in a figure 8 pattern.
- c. Secure cord by inserting end between wrapped section on cleat, pull to secure. Trim excess cord if position is to remain permanent.

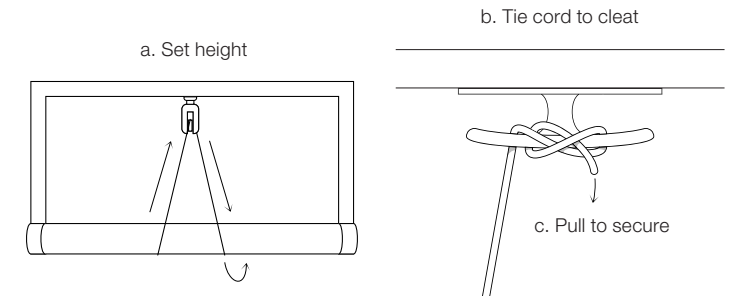

Side Returns

You'll find the side returns packaged on the belly band of the shade. Once shade is installed, attach the side returns on the end of the headrail using hook and loop fasteners.

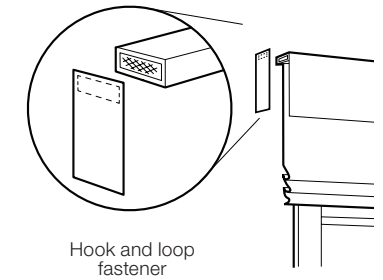

Care & Maintenance

- Vacuum Top Treatments with an upholstery attachment to remove dust, hair or other airborne particles.
- Prolonged exposure to the elements will result in visible wear.
- Ensure windows are dry to protect Top Treatments from moisture caused by window condensation or rain. Prolonged exposure to moisture and extreme humidity will cause discoloration from mildew, which can be difficult to remove.
- In the event that wrinkling occurs, use a dry iron on a low setting, increasing the heat as needed. Do not exceed the medium heat setting or use steam.

Warranty

Hartmann&Forbes warrants to the original purchaser ("purchaser") that its windowcoverings ("products" or "the product"), when correctly installed and operated in strict accordance with the installation instructions, will be free from defects in materials and workmanship for FIVE (5) YEARS from the date of delivery (the "Warranty Period").

Subject to the following warranty exclusions, any products or parts determined to be defective during the Warranty Period will be repaired or replaced by Hartmann&Forbes at no-charge to the purchaser.

NOT COVERED BY WARRANTY:

- Hartmann&Forbes products or parts which fail due to accident, alteration, improper use, abuse, neglect, normal wear, color-fading due to sunlight, atmospheric conditions, direct exposure to salt air or improper cleaning
- Any conditions or damage resulting from the removal of the product or reinstallation in the same or another window

- Labor costs and expenses associated with measuring and installing replacement products, shipping, packaging and returning merchandise, except as may be authorized by Hartmann&Forbes in advance

- Hartmann&Forbes motor-ready windowcoverings
- Customer-provided motors and parts
- Hartmann&Forbes Natural Wallcoverings
- Hartmann&Forbes By-the-Yard Textiles

To obtain Warranty service, contact the showroom or distributor from which you purchased your Hartmann&Forbes product(s) and, if it is determined that your claim is subject to warranty, Hartmann&Forbes will promptly repair or replace any defective parts at no-charge. Charge-backs for repair or installation costs will not be honored unless authorized by Hartmann&Forbes in advance. Hartmann&Forbes retains the right to determine the appropriate method for repairing or remaking any product.

AS-IS; NO OTHER WARRANTIES: THERE ARE NO OTHER WARRANTIES, EXPRESS OR IMPLIED, EXCEPT THIS LIMITED WARRANTY. HARTMANN&FORBES EXPRESSLY DISCLAIMS THE IMPLIED WARRANTIES OF MERCHANTABILITY AND FITNESS FOR A PARTICULAR PURPOSE.

LIMITATION OF REMEDIES: HARTMANN&FORBES SHALL NOT BE LIABLE FOR ANY DIRECT, INCIDENTAL OR CONSEQUENTIAL DAMAGES EXCEPT AS SPECIFICALLY LISTED ABOVE, AND SHALL NOT BE LIABLE IN ANY CIRCUMSTANCE FOR SPECIAL, INDIRECT, PUNITIVE, OR EXEMPLARY DAMAGES OR LOST PROFITS OF ANY KIND WHETHER BASED ON CONTRACT, WARRANTY, NEGLIGENCE, PRODUCT LIABILITY OR ANY OTHER THEORY OF RELIEF RESULTING FROM OR ARISING IN ANY WAY FROM YOUR PURCHASE OR USE OF HARTMANN&FORBES PRODUCTS.

Some states do not allow the exclusion or limitation of incidental or consequential damages, so the above limitation or exclusion may or may not apply to you.

If shade is damaged, the hardware is missing or if you need assistance please contact H&F at 888.582.8780 or email hfcf@hartmannforbes.com